

the box speaker

I0-250/8-A

I. Technical data:

Diameter :	250mm (10 inch)
DC impedance :	$5.6\Omega \pm 0.28\Omega$
Rated impedance :	8.0Ω
Min. impedance :	6.2Ω
Rated power (RMS):	250W
Peak power:	1000W
Sensitivity (1W/1m) :	94dB ± 2 dB
Min. resonance frequency :	56Hz ± 6 Hz
Frequency response:	56Hz-4.0kHz
Dia. of V.C.:	75.5mm
Material of V.C.:	round copper wire
Framework material of V.C. :	TIL
Coil height of V.C. :	12mm
Depth of magnet :	8mm
Flux Density:	0.9T

II. Drawing:

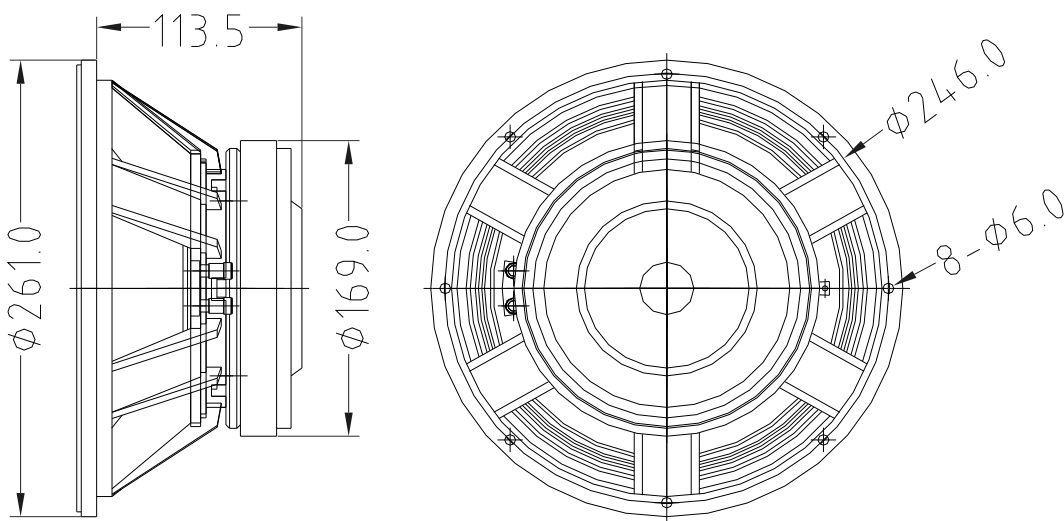

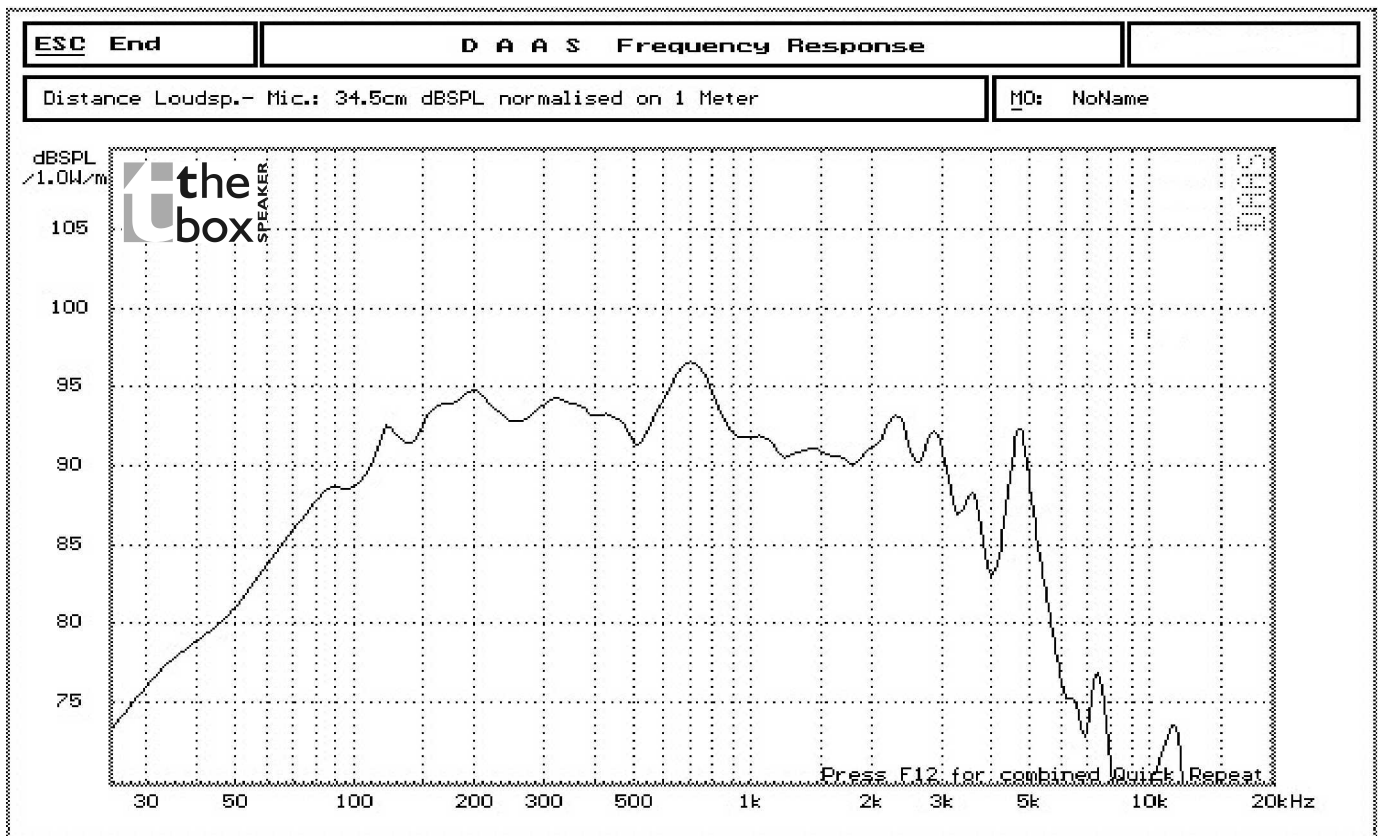
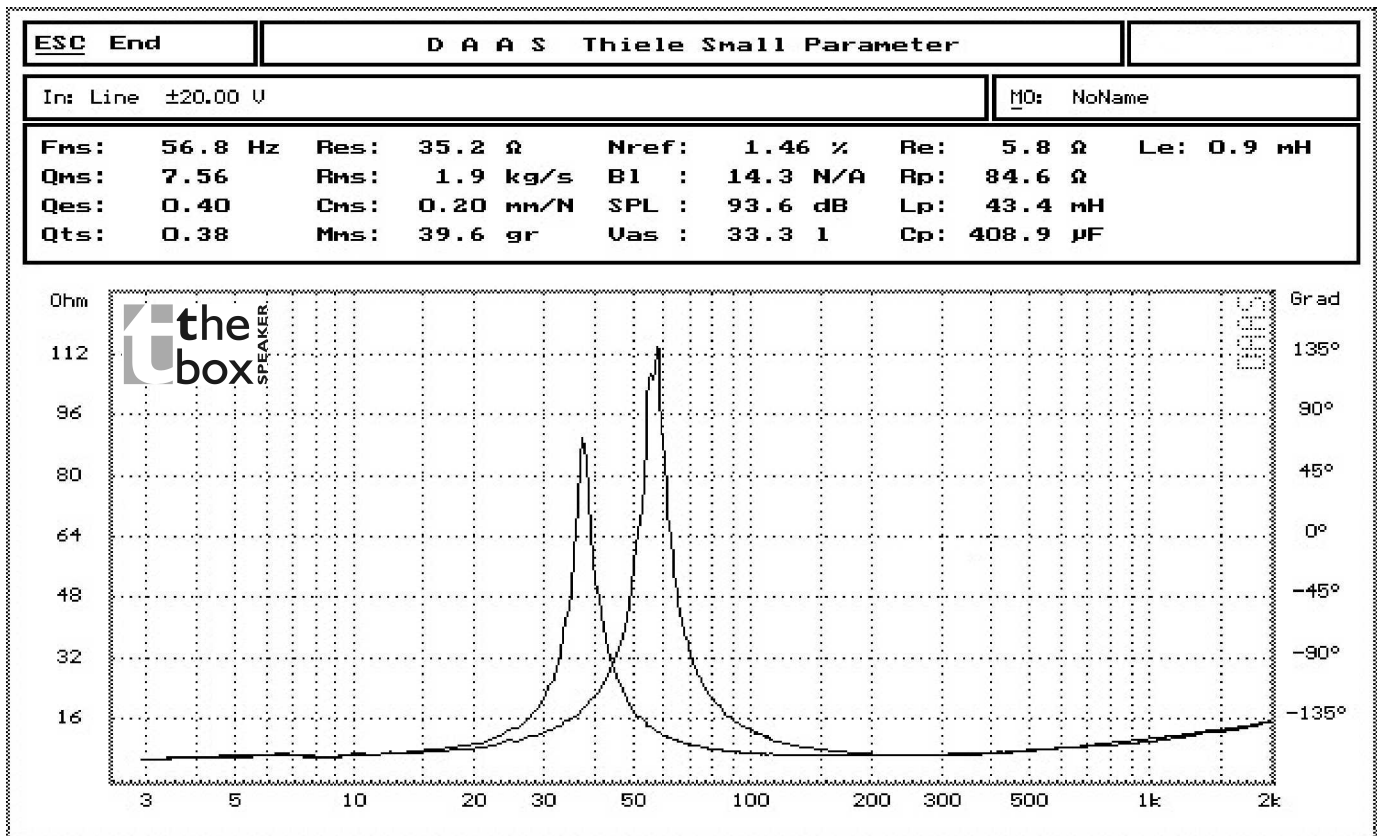

© 2006 Musikhaus Thomann - 96138 Burgebrach - Germany.

Kein Teil dieses Datenblatts darf, egal auf welche Weise, ohne schriftliche Genehmigung des Musikhaus Thomann vervielfältigt werden. Technische Änderungen vorbehalten.

Technical specifications and appearance subject to change without notice. No part of this datasheet may be reproduced or transmitted in any form or by any means, electronic or mechanical, including photo copying and recording of any kind, for any purpose, without the express written permission of Musikhaus Thomann.

R - 270406 KR